

Series A - Worm Gears  
Installation & Maintenance



benzlers   
with you at every turn

## Product Safety Information

## IMPORTANT

**General** - The following information is important in ensuring safety. It **must** be brought to the attention of personnel involved in the selection of power transmission equipment, those responsible for the design of the machinery in which it is to be incorporated and those involved in its installation, use and maintenance.

Our equipment will operate safely provided it is selected, installed, used and maintained properly. As with any power transmission equipment **proper precautions must be taken** as indicated in the following paragraphs, to ensure safety.

**Potential Hazards** - these are **not** necessarily listed in any order of severity as the degree of danger varies in individual circumstances. It is important therefore that the list is studied in its entirety:-

- 1) Fire/Explosion
  - (a) Oil mists and vapour are generated within gear units. It is therefore dangerous to use naked lights in the proximity of gearbox openings, due to the risk of fire or explosion.
  - (b) In the event of fire or serious overheating (over 300 oC), certain materials (rubber, plastics, etc.) may decompose and produce fumes. Care should be taken to avoid exposure to the fumes, and the remains of burned or overheated plastic/rubber materials should be handled with rubber gloves.
- 2) Guards - Rotating shafts and couplings must be guarded to eliminate the possibility of physical contact or entanglement of clothing. It should be of rigid construction and firmly secured.
- 3) Noise - High speed gearboxes and gearbox driven machinery may produce noise levels which are damaging to the hearing with prolonged exposure. Ear defenders should be provided for personnel in these circumstances. Reference should be made to the Department of Employment Code of Practice for reducing exposure of employed persons to noise.
- 4) Lifting - Where provided (on larger units) only the lifting points or eyebolts must be used for lifting operations (see maintenance manual or general arrangement drawing for lifting point positions). Failure to use the lifting points provided may result in personal injury and/or damage to the product or surrounding equipment. Keep clear of raised equipment.
- 5) Lubricants and Lubrication
  - (a) Prolonged contact with lubricants can be detrimental to the skin. The manufacturer's instruction must be followed when handling lubricants.
  - (b) The lubrication status of the equipment must be checked before commissioning. Read and carry out all instructions on the lubricant plate and in the installation and maintenance literature. Heed all warning tags. Failure to do so could result in mechanical damage and in extreme cases risk of injury to personnel.
- 6) Electrical Equipment - Observe hazard warnings on electrical equipment and isolate power before working on the gearbox or associated equipment, in order to prevent the machinery being started.
- 7) Installation, Maintenance and Storage
  - (a) In the event that equipment is to be held in storage, for a period exceeding 6 months, prior to installation or commissioning, we must be consulted regarding special preservation requirements. Unless otherwise agreed, equipment must be stored in a building protected from extremes of temperature and humidity to prevent deterioration.  
The rotating components (gears and shafts) must be turned a few revolutions once a month (to prevent bearings brinelling).
  - (b) External gearbox components may be supplied with preservative materials applied, in the form of a "waxed" tape overwrap or wax film preservative. Gloves should be worn when removing these materials. The former can be removed manually, the latter using white spirit as a solvent.  
Preservatives applied to the internal parts of the gear units do not require removal prior to operation.
  - (c) Installation must be performed in accordance with the manufacturer's instructions and be undertaken by suitably qualified personnel.
  - (d) Before working on a gearbox or associated equipment, ensure that the load has been removed from the system to eliminate the possibility of any movement of the machinery and isolate power supply. Where necessary, provide mechanical means to ensure the machinery cannot move or rotate. Ensure removal of such devices after work is complete.
  - (e) Ensure the proper maintenance of gearboxes in operation. Use only the correct tools and our approved spare parts for repair and maintenance. Consult the Maintenance Manual before dismantling or performing maintenance work.
- 8) Hot Surfaces and Lubricants
  - (a) During operation, gear units may become sufficiently hot to cause skin burns. Care must be taken to avoid accidental contact.
  - (b) After extended running the lubricant in gear units and lubrication systems may reach temperatures sufficient to cause burns. Allow equipment to cool before servicing or performing adjustments.
- 9) Selection and Design
  - (a) Where gear units provide a backstop facility, ensure that back-up systems are provided if failure of the backstop device would endanger personnel or result in damage.
  - (b) The driving and driven equipment must be correctly selected to ensure that the complete machinery installation will perform satisfactorily, avoiding system critical speeds, system torsional vibration, etc.
  - (c) The equipment must not be operated in an environment or at speeds, powers, torques or with external loads beyond those for which it was designed.
  - (d) As improvements in design are being made continually the contents of this catalogue are not to be regarded as binding in detail, and drawings and capacities are subject to alterations without notice.

The above guidance is based on the current state of knowledge and our best assessment of the potential hazards in the operation of the gear units.

Any further information or clarification required may be obtained by contacting our Application Engineers.

<b>Section</b>	<b>Description</b>	<b>Page No</b>
1	Declaration of Conformity / Incorporation	1
1	General Information	2
2	Weather Protection	2
3	Reading the Nameplate	2
4	 Marking	4
5	Installation	
	5.1 General Information	5
	5.2 Prior to Installation	5
	5.3 Fitting Components to Input or Output Shafts	5
	5.4 Lifting	6
	5.5 Installing Foot mount units	6
	5.6 Installing Shaft Mount Units	7
	5.7 Units for use in a potentially explosive atmosphere	7
6	Lubrication	
	6.1 General Information	9
	6.2 Ventilator	9
	6.3 Oil Level	9
	6.4 Approved Lubricants	9
7	Motor Connections	10
8	Starting Up	10
9	Operation	
	9.1 Noise	10
	9.2 General Safety	10
	9.3 Initial start up for Gear Units Operating in a Potentially explosive atmosphere	10
10	Maintenance	
	10.1 Prior to any Maintenance Operations	11
	10.2 Oil Plugs & Ventilator	11
	10.3 Lubrication	11
	10.4 Grease Lubrication	12
	10.5 Cleaning	12
11	Fault Diagnosis	13
<b>Appendix</b>		
1	Shaft Alignment	14
2	Shaft Mount Units	16-17
2A	Torque Arm Details	18-19
3	Three Phase Induction Motor Installation	20
4	Lubrication	21
5	Approved Bearing Greases	29

## Safety Warning Symbols



**Electrical Hazard**  
Could result in death or serious injury



**Danger**  
Could result in serious, slight or minor injuries



**Danger (Touch Hazard)**  
Could result in death or serious injury



**Damaging Situation**  
Could result in damage to gear unit or driven machinery



Important notes on Explosion Protection



**Cleaning**  
Periodic cleaning necessary

**Declaration of Conformity**

Products:

**Series AJ & AM - Worm Gear Units.**

Radicon Transmission UK Ltd hereby declares that products listed above have been designed in accordance with the following Directives and Standards.

- The Machinery Directive 2006/42/EC
- EN ISO 12100-1,2 The Safety of Machinery
- Conforms to all other harmonised standards, tests, and specifications, (In as much as they apply to our products)

**Declaration of Incorporation**

According to Machinery Directive 2006/42/EC Annex IIB

This product must not be put into service until the machinery into which it is to be incorporated has been declared in conformity with the provisions of the machinery directive 2006/42/EC.

The equipment shall only be loaded within the framework of our recommendations, and installed and operated in accordance with our installation and maintenance instructions.

The company hereby draws attention to the dangers of improper use of this equipment and particularly warns users against operating with inadequate guarding of rotating parts and the use of naked lights in close proximity to the equipment.

Radicon Transmission UK Ltd will, upon a reasoned request from national authorities, provide any relevant information on its products

Signed by:



ENGINEERING MANAGER  
Radicon Transmission UK Ltd

**Radicon Transmission UK Limited**

Unit J3 Lowfields Business Park,  
Lowfields Way, Elland, West Yorkshire, HX5 9DA  
United Kingdom

Tel: +44 (0)1484 465 800  
Fax: +44 (0)1484 465 801  
sales@radicon.com  
www.radicon.com

Company No 7397993 England

**1. General Information**

The following instructions will help you achieve a satisfactory installation of your Series A unit, ensuring the best possible conditions for a long and trouble free operation.

All units are tested and checked prior to despatch, a great deal of care is taken in packing and shipping arrangements to ensure that the unit arrives at the customer in the approved condition.

Series A gear units will perform satisfactorily if subjected to full load immediately after installation. However, optimum performance is best achieved by a process of gradual load increments, up to the full value, over the first 50 hours or so of their working life. During these early stages of running, sensible precautions should be taken to avoid overloads.

The gear unit operating temperature may be higher during this period of run-in. A progressive reduction in temperature may occur over many hours until the unit has reached its highest efficiency.

**2. Weather Protection of Unit**

All Series A units are provided with protection against normal weather conditions. Where units are to operate in extreme conditions, or where they are to stand for long periods without running, e.g. during plant construction, consult Application Engineering so that arrangements for adequate protection can be made.

**3. Reading the Nameplate**

**3.1 Unit Identification – Sizes A0280, A0410, A0510, A0610, A0730, A0860**



When requesting further information, or service support quote the following information from the nameplate:

- Unit type (Model No)
- Order Number / Year of Manufacture

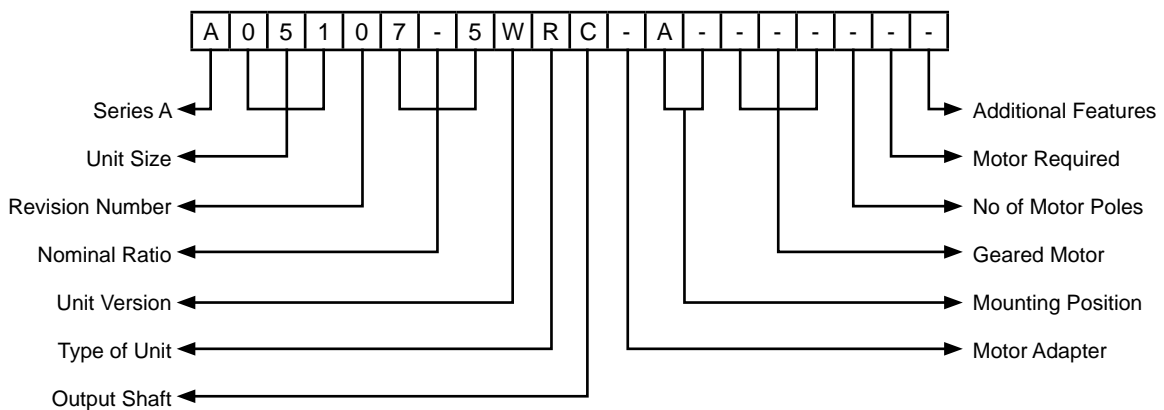

**3.2 Unit Identification – Sizes A1002, A1252, A1602, A2002**

<b>SERIES A</b>			
TYPE	A 1 2 5 2 5 0 . W R C - 1 - - - - -		
ORDER No.	B100169/03	OUTPUT RPM	29.0
INPUT POWER	3.0 kW	ASSEMBLY POSITION	1
RATIO	50 : 1	OIL GRADE	6G
			II 2 G EEx c,k, T4
LUBRICATION			
Fill to correct Oil Level with oil of recommended grade.			
<input type="checkbox"/> Drain and flush at end of oil change period. See approved Lubricants leaflet for further details			

When requesting further information, or service support quote the following information from the nameplate:

- Unit type (Model No)
- Order Number / Year of Manufacture

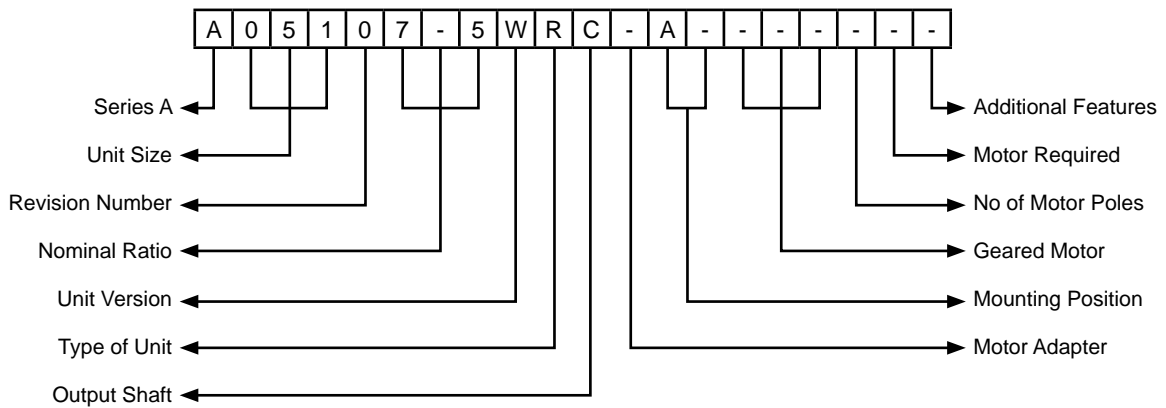

**Lubrication Grade**

Series A0280, A0410, A0510, A0610, A0730 and A0860 units are supplied lubricated for life. (Factory filled with synthetic lubricant). Our lubrication grade is marked on the nameplate. See Appendix 2 for type and quantity of lubricant.

4.  **Marking**





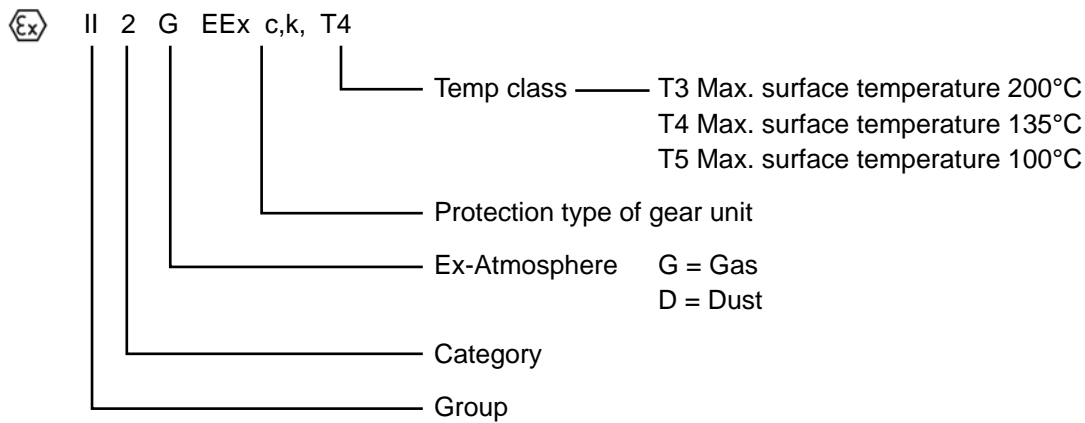

These gear units are intended for use in industrial systems.

Provided they are correctly installed in accordance with these instructions (gear units only) they comply with the EU directive 94/9/EC ATEX 100a Group II Cat 2 zones 1 & 21 & Cat 3 zones 2 & 22. Motors, couplings, or any other equipment fitted to the gear unit must also comply with this directive. If the gear unit is supplied as a geared motor package it is important to check the nameplates of the gear unit and the motor (or any other equipment fitted) corresponds with the classification of the potentially explosive atmosphere in which the unit is to be installed.

**Understanding EU Directive 94/9/EC (ATEX 100a) Markings.**



**Examples:**

-  II 2 G - (Zone 1) occasional hazardous explosive atmosphere
-  II 3 G - (Zone 2) rare short-term hazardous explosive atmosphere
-  II 2 D - (Zone 21) occasional hazardous explosive atmosphere during normal operation due to presence of combustible dust
-  II 3 D - (Zone 22) short-term hazardous explosive atmosphere due to presence of combustible dust; no hazard during normal operation

## 5. Installation

### 5.1 General

#### WARNING!



CAUTION

The customer shall be responsible for the proper use of articles supplied by the company, particularly the rotating shafts between their driving and driven members, and their guarding for safety, and the company shall not be responsible for any injury or damage sustained as a result of the improper use of the articles supplied.

Attention is hereby drawn to the danger of using naked lights in proximity to openings in gearboxes and gear units supplied by the company, and the company shall not be liable for any claim for injury or damage arising from any action in contravention of this warning.

### 5.2 Prior to Installation

- 5.2.1. Check gear unit has not been damaged.
- 5.2.2. Check the gear unit / motor nameplate matches the requirements of the machine the unit is to be installed into.
- 5.2.3. Thoroughly clean the shaft and mounting surfaces that are to be used of anti-corrosion agents using a commercially available solvent. Ensure solvent does not make contact with the oil seals.



### 5.3. Fitting of Components to Either the Unit Input or Output Shaft

The input or output shaft extension diameter tolerance is to ISO tolerance k6 (for shaft diameter  $\leq 50\text{mm}$ ) and m6 (for shaft diameter  $> 50\text{mm}$ ) and the fitted components should be to ISO tolerance M7 (for bore diameter  $\leq 50\text{mm}$ ) and K7 (for bore diameter  $> 50\text{mm}$ ).

- 5.3.1. Ensure shaft extensions, bores & keys etc are cleaned.
- 5.3.2. Items (such as gears, sprockets, couplings etc) should not be hammered onto these shafts since this would damage the shaft support bearings.
- 5.3.3. The item should be pushed onto the shaft using a screw jack device fitted into the threaded hole provided in the end of the shaft. See Table 1 below.
- 5.3.4. Items being fitted may be heated to 80/100°C to aid assembly further.

Unit Size	Input Shaft (Single Reduction)	Input Shaft (Double Reduction)	Output Shaft
A0280	-	-	-
A0410	-	-	-
A0510	-	-	-
A0610	-	-	-
A0730	-	-	-
A0860	-	-	-
A1002	M12 x 25 mm deep	-	M16x 36mm deep
A1252	M12 x 25 mm deep	-	M20 x 43mm deep
A1602	M12 x 25 mm deep	-	M20 x 43mm deep
A2002	M12 x 25 mm deep	M12 x 25 mm deep (M8 x 19mm deep motorised)	M24 x 52mm deep

**Table 1**



## 5.4 Lifting

Only the lifting points identified below must be used for lifting operations during installation. Larger Series A Units are supplied with a lifting eye.

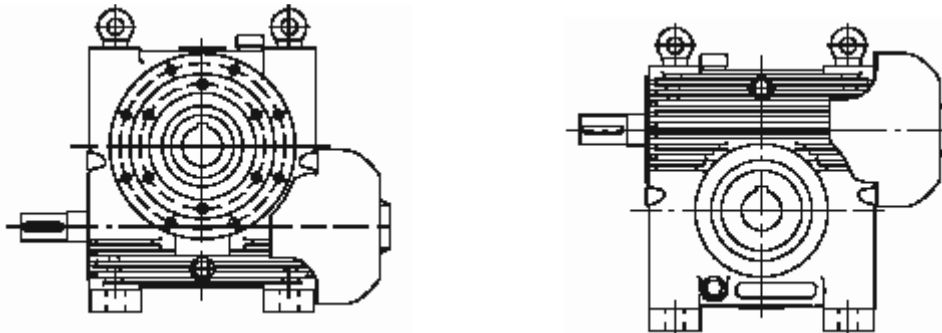

On units supplied with a lifting eye on the motor, both the lifting point on the gear unit and motor should be used.

### 5.5 Foot Mounted or Flange Mounted Units

5.5.1. Ensure the base foundation mounting surface is flat<sup>1</sup>, vibration absorbing and torsionally rigid.

Note: Units on baseplates should if possible be mounted on the same bedplate as the prime mover.

5.5.2. The gear unit must be installed in the specified mounting position. The maximum deviation from the designated mounting position is  $\pm 5^\circ$  (unless gear unit is suitably modified and approved for non standard mounting positions).

5.5.3. Align unit (see Appendix 1).

Note: It is important to ensure when aligning unit on baseplate that all machined mounting points are supported over their full area.

If steel packings are used, these should be placed either side of the foundation bolt as close as possible.

During final bolting ensure the unit or baseplate is not distorted as this would cause strains in the gear case resulting in errors of alignment of shafts and gearing.

Check all mounting points are fully supported and adjust if necessary by using steel packings.

Torque tighten bolts to torque specified in Table 2 below.

5.5.4. Secure unit, or baseplate if fitted to a rigid foundation using heavy duty bolts to ISO grade 8.8 minimum.

Set Screw Size	Tightening Torque				
	Holding Down Bolts/ Output Flange Bolts				
M6	10	Nm	=	89	Lbf.in
M8	25	Nm	=	221	Lbf.in
M10	50	Nm	=	442	Lbf.in
M12	85	Nm	=	752	Lbf.in
M16	200	Nm	=	1770	Lbf.in
M20	350	Nm	=	3097	Lbf.in
M24	610	Nm	=	5400	Lbf.in
M30	1220	Nm	=	10800	Lbf.in
M36	2150	Nm	=	19030	Lbf.in

Table 2

<sup>1</sup> Maximum permissible flatness error for mounting surface is 0.12mm.

## 5.5.5. A0280, A0410, A0510, A0610, A0730, A0860

Fitting Feet type will be G or H.

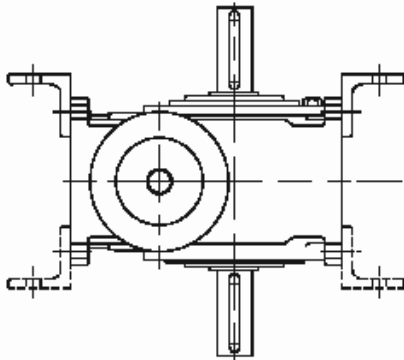

**Feet Type G**

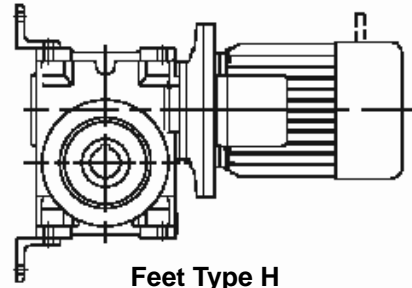

**Feet Type H**

Secure feet using fasteners provided  
Torque Tighten to the values shown  
in the table

Tightening Torque For Feet Bolts			
Size	Nm	Lbf.in	Bolt Size
A0280	25	221	M8
A0410	50	442	M10
A0510	50	442	M10
A0610	50	442	M10
A0730	85	752	M12
A0860	200	1770	M16

- 5.5.6. For sizes A1002, A1252, A1602, A2002 Fitting feet on units mounted in positions 1 and 2. Series A mid range units are fitted with detachable feet in mounting positions 1 and 2. These are normally factory fitted to clients specification, but if for any reason the feet are supplied separately, or dismantling is necessary after supply, they should be re-fitted and torque tightened to the values shown in the table.

Tightening Torque For Feet Bolts			
Size	Nm	Lbf.in	Bolt Size
A1002	350	3097	M20
A1252	350	3097	M20
A1602	610	5400	M24
A2002	610	5400	M24

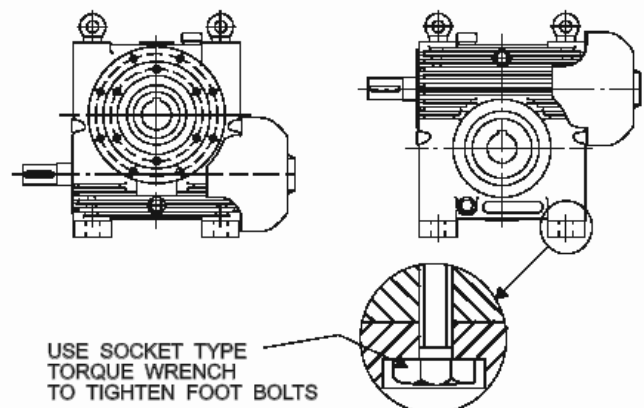

## 5.6 Shaft Mounted Units

- 5.6.1. The gear unit must be installed in the specified mounting position.
- 5.6.2. Assembly of gear unit on to the machine shaft(See Appendix 2)
- 5.6.3. Anchor gear unit to a secure point on the structure by means of torque arm. (See Appendix 2A).



## 5.7. Units for Use in a Potentially Explosive Atmosphere

- 5.7.1. If the unit has been damaged in transit do not use. (Remove all transport fixtures and packings prior to start up)
- 5.7.2. Check nameplate of unit corresponds with the sites potentially explosive atmosphere classification.
- 5.7.3. Check ambient temperature falls within lubricant grade recommendations. (See Approved Lubricants p23)
- 5.7.4. Make sure no potentially explosive atmosphere exists during installation.
- 5.7.5. Make sure that gear unit is sufficiently ventilated with no external heat input – cooling air temperature should not exceed 40°C
- 5.7.6. Ensure mounting position corresponds to that marked on the nameplate. (Note! ATEX approval is only valid for mounting position specified on the nameplate.)
- 5.7.7. Check motors, couplings or any other equipment fitted to the gear unit has ATEX approval. Check information listed on nameplates correspond to the environmental conditions of the site.
- 5.7.8. Ensure gearbox is not subjected to any loading greater than those marked on the nameplate.
- 5.7.9. For units operated with inverter drives, check motor suitability for use with the inverter. Ensure that the inverter parameters do not exceed those of the motor.
- 5.7.10. For belt driven units, check all belts fitted are of sufficient electrical leakage resistance. ( $< 10^9 \Omega$ ).
- 5.7.11. Ensure gear unit and other equipment is electrically grounded (Earthed).
- 5.7.12. Check and adjust guards or covers so that there is no ignition source from sparks that may be thrown by moving parts making contact with guards etc. Ensure coupling guards, covers etc are dust tight or are designed in such a way that a build up of dust deposits cannot form when the unit is used in Zone 21 & Zone 22 classification areas.

## 6. Lubrication

### 6.1. General

- 6.1.1. Sizes A0280, A0410, A0510, A0610, A0730 & A0860 units are factory filled with a Polyglycol based synthetic lubricant. They are “Lubricated for Life” and require no routine maintenance in service. In the event of a major overhaul involving strip-down and re-assembly of the gear unit refer to approved lubricants & Lubricant quantities.
- 6.1.2. Sizes A1002, A1252, A1602 and A2002 single reduction will be oil filled by client. Sizes A1002, A1252 and A1602 double reduction, primary unit will be factory filled for life with synthetic lubricant, secondary unit will be filled by client. Size A2002 double reduction, primary and secondary unit will be oil filled by client.



CAUTION

### 6.2. Ventilator

- 6.2.1. Clean & secure the ventilator (if supplied) in the correct location for the required mounting position. (see Appendix)

### 6.3. Oil Level

#### Units supplied without oil :

- 6.3.1. Fill gear unit with correct type of lubricant to the level marked on the dipstick or any other level indicated to them (e.g. Sight glass)
- 6.3.2. Where possible run the unit without load for a short time to circulate the lubricant thoroughly, then stop the unit and re-check the oil level after allowing the unit to stand for 10 minutes and if necessary top up to the correct mark on the dipstick or any other level indicator fitted (sight glass etc.).



CAUTION

**WARNING** Do not overfill as excess may cause overheating and leakage.

- 6.3.3. Re-fit plugs & tighten to correct torque figure – see notes in maintenance section. Clean away any oil spillage from the surface of the gear unit and driven machinery.

### 6.4. Approved Lubricants

- 6.4.1. Oils  
See Appendix 4 for lubricants approved for use in the gear unit.
- 6.4.2. Greases  
See Appendix 5 for greases approved for use in the gear unit.

## 7. Motor Connections



### To mains:

- 7.1. Connection of the electric motor to the mains supply should be made by a qualified person. The current rating of the motor will be identified on the motor plate, and correct sizing of the cables to electrical regulations is essential.

### Motor terminal connection:

- 7.2. Circuit diagrams for the correct wiring of the motor terminal box are included as Appendix 3 of this document if the motor is fitted with our 'own brand' motor. Alternatively if the motor is supplied separately or if fitted with a motor from a different manufacturer, then this should have appropriate documentation provided with it.

## 8. Starting Up



### 8.1. Prior To Starting Up

- 8.1.1. Ensure ventilator is fitted (if supplied) see lubrication section 6.2
- 8.1.2. Check oil level, top up if necessary.
- 8.1.3. Ensure all safety devices are in place (i.e. guards fitted). Check and adjust guards or covers so that there is no ignition source from sparks that may be thrown by moving parts making contact with guards etc. Ensure coupling guards, covers etc are dust tight or are designed in such a way that a build up of dust deposits cannot form when the unit is used in Zone 21 & Zone 22 classification areas.
- 8.1.4. Remove any safety devices fitted to prevent machine rotation.
- 8.2. Starting up should only be performed or supervised by suitably qualified personnel.

Caution: Any deviation from normal operating conditions, (increased temperature, noise, vibrations, power consumption etc) suggests a malfunction, inform maintenance personnel immediately.

- 8.3. Units fitted with backstop, ensure motor is correctly wired for free direction of rotation.

## 9. Operation



### 9.1. Noise

The range of product satisfies a noise (sound pressure level) of 85 dB(A) or less when measured at 1 metre from the unit surface.  
Measurements taken in accordance with BS.7676 Pt1 : 1993 (ISO 8579-1 : 1993).



### 9.2. General Safety

Potential hazards which can be encountered during installation, maintenance and operation of drives is covered in greater detail in the product safety page at the front of this booklet.

Advice is also given on sensible precautions which need to be taken to avoid injury or damage.

**PLEASE READ!**



### 9.3. Initial Start Up For Gear Units Operating In A Potentially Explosive Atmosphere

After 3 hours of operation check the gear unit surface temperature. This temperature should not exceed 110°C. If the temperature exceeds this limit, shut down immediately and contact your local sales office

## 10. Maintenance



### 10.1. Prior To Any Maintenance Operations

- 10.1.1. De-energise the drive and secure against un-intentional switch on.
- 10.1.2. Wait until the unit has cooled down – Danger of skin burns & pressure build up.



### 10.2. Oil Plugs / Ventilator

- 10.2.1. Prior to removing plugs, ensure that the unit has cooled sufficiently so that oil will not burn on units without ventilator. Warning – do not stand over plug whilst removing as pressure build up may cause it to eject when removed.
- 10.2.2. Place a container under the oil drain plug to be removed. Note: it is recommended that the oil should be slightly warm, (40-50°C) when drained. (Cooler oil will be more difficult to drain correctly).
- 10.2.3. Top ups or refills should be done (where possible) through the ventilator position.
- 10.2.4. Remember to refit all plugs and torque tighten to Table M1 below.



Plug Size	Tightening Torque	
M10	12 Nm	= 106lbf.in
M12	20 Nm	= 177lbf.in
M14	26 Nm	= 230lbf.in
M16	34 Nm	= 300lbf.in
M22	65 Nm	= 575lbf.in

**Table M1**

- 10.2.5. Clean away any oil spillage.



### 10.3. Lubrication

#### 10.3.1. Periodic inspection:

For Units fitted with level indicating device, check the oil level every 1000 hours or 6 months whichever is sooner and if necessary top up with the recommended type of lubricant.

#### 10.3.2. Oil changes:



- Smaller units (supplied without ventilator) are supplied lubricated for life except for the following conditions:  
Units that are required to work in explosive atmosphere (94/9/EC Atex 100a Group II category 2 zones 1 & 21 & category 3 zones 2 & 22) should be drained and refilled with correct quantity of lubricant in accordance with the renewal period of the table below. See Appendix for current oil quantity.
- Larger units (supplied with ventilator) should be drained and refilled with correct quantity of lubricant in accordance with the renewal period of the table below. See Appendix for correct oil quantity.
- Regular oil changes are essential and the following factors should be used to determine the frequency at which these are carried out.
  - a. Oil temperature – unit operating under load
  - b. Type of oil
  - c. Environment – humidity, dust, etc.
  - d. Operating conditions – shock, loading, etc.

At elevated temperatures the effective life of the oil is very much reduced. To prevent damage to the unit through lubricant breakdown the oil should be renewed as detailed in Table M2.

Unit Operating Temperature °C	Renewal Period				
	Synthetic Oil				
65 or LESS	26000	HOURS	OR	3	YEARS
70	26000	HOURS	OR	3	YEARS
75	22000	HOURS	OR	3	YEARS
80	15000	HOURS	OR	3	YEARS
85	10500	HOURS	OR	3	YEARS
90	7500	HOURS	OR	2½	YEARS
95	6000	HOURS	OR	2	YEARS
100	4500	HOURS	OR	18	MONTHS

NB: INITIAL FILL OF OIL SHOULD BE CHANGED IN A NEW GEAR UNIT AFTER 1000 HOURS OPERATION OR ONE YEAR OR HALF THE ABOVE LIFE WHICHEVER IS THE SOONEST.

**NOTE:**

Figures quoted are for oil temperatures when the unit has attained normal running temperature when operating under load. These figures are based on normal running but where conditions are particularly severe it may be necessary to change the oil more frequently. When changing lubricant, if same lubricant is not used then unit must be flushed out and filled with one type of lubricant.

Table M2



CAUTION

Warning

Do not mix Synthetic and Mineral lubricants.  
Do not overfill the unit as this can cause leakage and overheating.



**10.4. Bearings**

10.4.1. Bearings should be replaced every 5 years for  marked units.

**10.5. Grease Lubrication**

10.5.1. Where re-greasing points are provided add 2 shots monthly of NLGI 2 grade grease.



**10.6. Cleaning**

10.6.1. With the drive stationary periodically clean any dirt or dust from the gear unit and the electric motor cooling fins and fan guard to aid cooling.



10.6.2. Ensure build up of dirt or dust does not exceed 5mm (maximum).

## 11. Fault Diagnosis

### 11.1. Gear Unit Problems:

Symptom	Possible Causes	Remedy
Output shaft does not rotate, even though the motor is running or the input shaft is rotating.	Drive between shafts interrupted in the gear unit.	Return the gear unit / geared motor for repair.
Unusual, regular running noise	a) A meshing or grinding sound :damage to bearings b) A knocking sound : irregularity in gearing	a) Check oil (See Inspection and Maintenance) b) Contact our Application Engineers
Unusual, irregular running noise	Foreign matter present in the oil	a) Check oil (See Inspection and Maintenance) b) Stop the unit, contact our Application Engineers
Oil leaking <sup>1</sup> • from gear unit cover • from motor flange • from gear unit flange • from output end oil seal	a) Defective gasket on gear unit cover b) Defective gasket c) Gear unit not ventilated	a) Retighten screws on gear unit cover and observe gear unit. If oil still leaks contact our Application Engineers b) Contact our Application Engineers c) Vent the gear unit. (See Appendix 4 - Mounting position)
Oil leaking from the ventilator	a) Gear unit over filled with oil b) Gear unit installed in an incorrect mounting position c) Frequent cold starts (oil foaming) and/or high oil level	a) Correct the oil level (See Lubrication) b) Fit the ventilator in the correct position (See Appendix 4 - Mounting position) and check oil level (see lubrication) c) Check the oil level (See Lubrication)

1) It is normal for small amounts of oil / grease to leak out of the oil seal during the running in period (24 hours running time)

**When contacting our sales office  
Please have the following information available:**

- Nameplate data (complete)
- Type and extent of the problem encountered
- The time and the circumstances the problem occurred
- A possible cause

**Any further information or clarification required may be obtained by contacting our sales office, please see contact details at the back of this booklet.**



## Shaft Alignment.

Errors of alignment fall into categories of angularity (see Figure 1) and eccentricity (see Figure 2), or a combination of both.

Errors of angularity should be checked for, and corrected, before errors of eccentricity.

Alignment in accordance with the following procedure will ensure vibration levels meeting those set out in ISO 10816 Part 1.

### Errors of Angularity

If the faces are perfectly true, the angularity can be checked by keeping both shafts stationary and taking measurements with a block gauge and feelers at the four points 1, 2, 3 and 4 as shown in Figure 3. The difference between the readings 1 and 3 will give the error of alignment in the vertical plane, over the length of the shaft equal to the diameter of the coupling flanges, and from this the difference in the relative heights of the feet of the motor or other connected machine can be found by proportion. Similarly, the difference between the reading 2 and 4 gives the amount of sideways adjustment necessary to correct any errors of alignment in the horizontal plane.

Generally, however, the coupling faces will not be absolutely true and whilst any errors so found could be allowed for in checking angularity by the stationary method an easier method presents itself. This consists in making the points 1 on both "A" and "B" and rotating both half couplings, keeping the marked points together. By taking measurements each quarter-revolution the errors in the vertical and horizontal planes are again found.

NOTE: Check the alignment after running the unit until it has attained its normal working temperature. Any discrepancies can then be rectified.

The permitted angularity error is as follows :

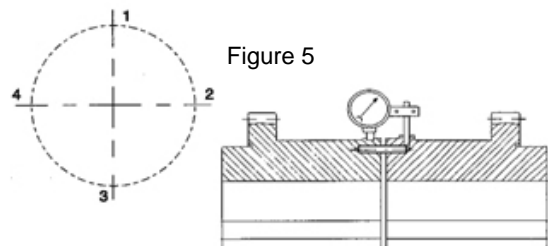
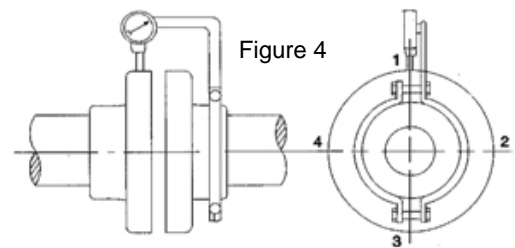
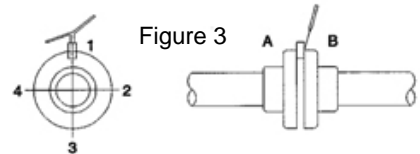
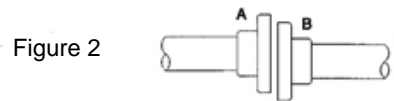
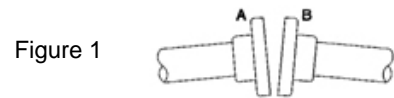

Type of Coupling	Allowable Gap (G) (mm)
Rigid Coupling	$G = 0.0005 D$
All other types	Please see appropriate Installation and Maintenance Manual for coupling type fitted

NOTE: D is the diameter (mm) at which the gap is measured.

## **Errors of Eccentricity**

The procedure for measuring eccentricity is precisely analogous to that used for angularity. In this case, however, the measurements are taken in a radial direction and the most convenient and accurate means of doing this utilises a dial indicator suitably clamped to one half coupling, and bearing on the hub or flange of the other, as shown in Figures 4 and 5 on Page 14.

Care however must be taken to ensure the support for the dial indicator is sufficiently rigid to prevent the weight of the indicator from causing deflection and, in consequence, inaccurate readings. Extra care should be taken where taper roller bearings are fitted to ensure that alignment is checked with shafts in mid-point position and a final check made with the unit at operating temperature.

The permitted eccentricity error which can be accommodated in addition to that of the angularity error is as follows:-

<b>Type of Coupling</b>	<b>Unit Size</b>	<b>Allowable Eccentricity (mm)</b>
Rigid	SIZE 08 & UNDER	0.025
	SIZE 09 & OVER	0.035
All other types	Please see appropriate installation and maintenance manual for coupling type fitted	

## **SPECIAL NOTE CONCERNING RIGID COUPLINGS**

In lining up elements involving rigid couplings it is important that no attempt is made to correct errors of alignment or eccentricity greater than those above by tightening of the coupling bolts. (This applies when the system is cold or at operating temperature). The result is misalignment and the setting up of undue stresses in the shaft, coupling and bearings. This will be revealed by the springing apart of the coupling faces if the bolts are slackened off. A check on the angularity of a pre-assembled job, after bolting down, can be obtained in the case of rigid couplings by slackening off the coupling bolts, when any misalignment will cause the coupling faces to spring apart. This check may not, however, reveal any strains due to eccentricity owing to the constant restraint imposed by the spigot.

## **SERIES X COUPLINGS**

We produce standard flexible couplings to cover our complete range of units, please contact your local sales office for details.

**Shaft Mount Units**  
**Customer Shaft Detail**

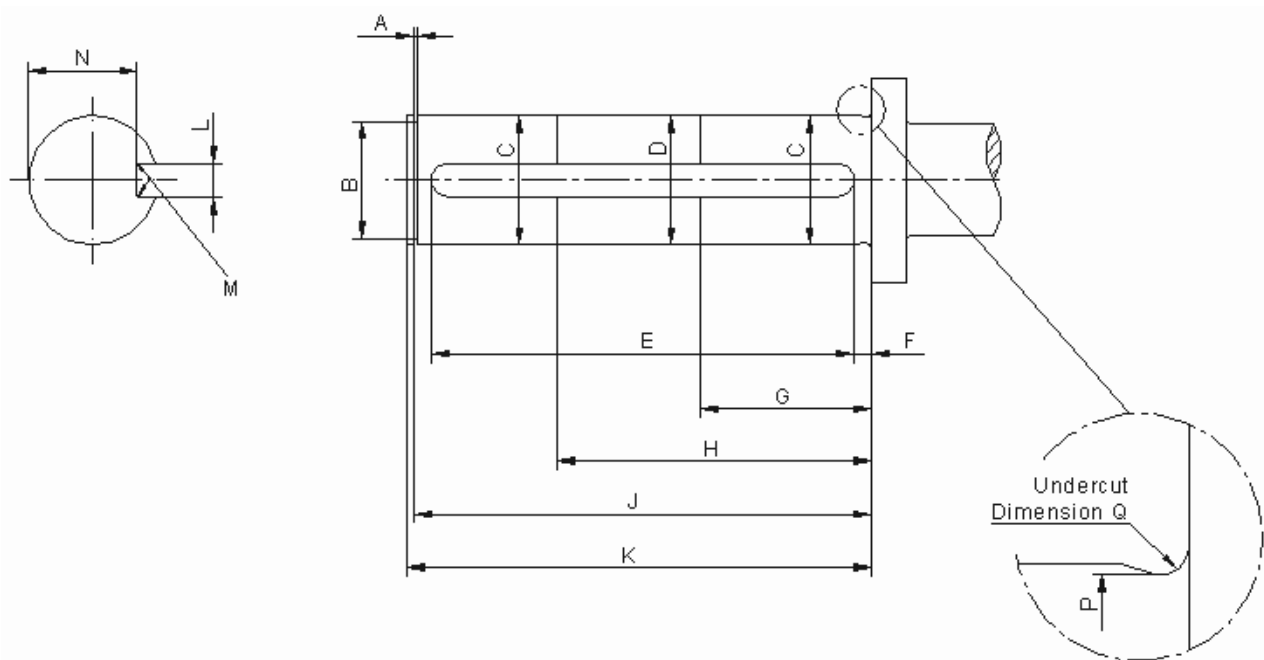

Size	A	B	C	D	E	F	G	H	J	K	L	M	N	P	Q	Key	Circlip
A0280	1.24 1.10	15.20 15.09	16.000 15.982	-	60.6 60.0	7	-	-	81.10 81.00	83	4.988 4.958	0.28R 0.16R	13.00 18.90	14.0	0.8R	5x5x 60	D1400- 0160
A0410	1.44 1.30	21.00 20.87	22.007 21.979	-	80.6 80.0	7	-	-	101.30 101.20	103	5.984 5.958	0.25R 0.16R	18.50 18.40	20.0	0.8R	6x6x 80	D1400- 0220
A0510	1.44 1.30	23.90 23.69	25.000 24.979	-	90.6 90.0	7	-	-	113.30 113.20	115	7.985 7.949	0.25R 0.16R	21.00 20.80	23.0	0.8R	8x7x 90	D1400- 0250
A0610	1.74 1.60	33.00 32.75	35.000 34.975	-	110.6 110.0	7	-	-	129.60 129.50	132	9.985 9.949	0.40R 0.25R	30.00 29.80	33.0	0.8R	10x8x 100	D1400- 0350
A0730	1.99 1.85	37.50 37.25	90.000 39.975	-	125.6 125.0	7	-	-	155.85 155.75	159	11.982 11.939	0.40R 0.25R	35.00 34.80	38.0	0.8R	12x8x 125	D1400- 0400
A0860	2.29 2.15	47.00 46.70	50.000 49.975	-	155.6 155.0	7	-	-	188.10 188.00	192	13.982 13.939	0.40R 0.25R	44.50 44.30	48.0	0.8R	14x9x 155	D1400- 0500
A1002	2.29 2.15	47.00 46.70	50.000 49.975	49.62 49.38	185.5 185.0	7	70	130	202.15 202.10	207	13.982 13.939	0.40R 0.25R	44.50 44.30	48.0	1.2R	14x9x 185	D1400- 0500
A1252	2.79 2.65	62.00 61.70	65.000 64.970	64.62 64.38	225.5 225.0	7	85	155	242.65 242.60	248	17.982 17.939	0.40R 0.20R	58.00 57.80	62.5	1.2R	18x11x 225	D1400- 0650
A1602	2.79 2.65	72.00 71.70	75.000 74.970	74.62 74.38	260.5 260.0	7	95	180	277.65 277.60	283	19.978 19.926	0.60R 0.40R	63.50 63.20	73.0	1.2R	20x12x 260	D1400- 0750
A2002	3.33 3.15	86.50 86.15	90.000 89.965	89.62 89.38	280.5 280.0	7	105	190	298.15 298.10	304	24.978 24.926	0.60R 0.40R	81.00 80.80	88.0	1.2R	25x14x 280	D1400- 0900

1. Fit Key into Shaft
2. Spray Shaft and gear unit bore with antifret compound
3. Fit gear unit onto hollowshaft
4. Secure with circlip (See: also alternative fixing methods)
5. Fit protective cover (Over non drive end)

## Alternative Shaft Fixing Methods

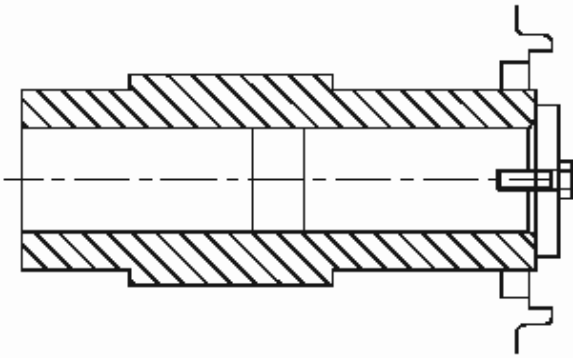

SHAFT MOUNT UNITS RETAINED WITH A BOLT AND PLATE

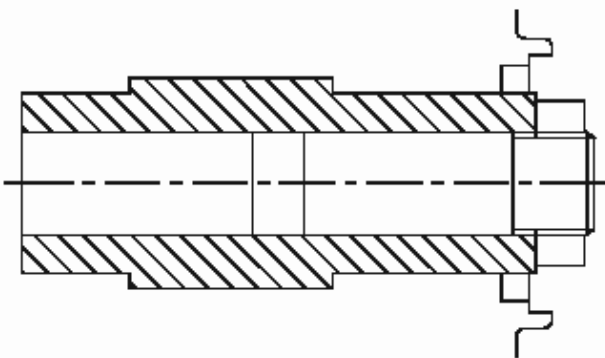

SHAFT MOUNT UNITS RETAINED WITH A LOCKNUT

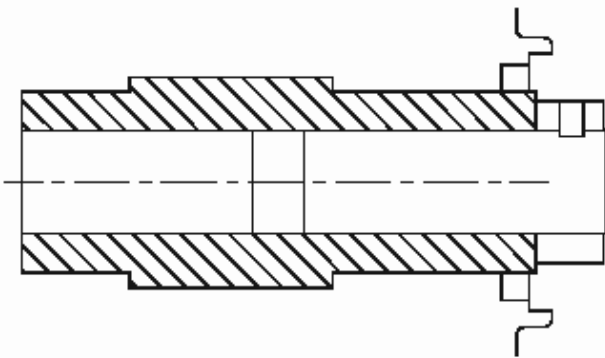

SHAFT MOUNT UNITS RETAINED WITH A COLLAR AND GRUBSCREW

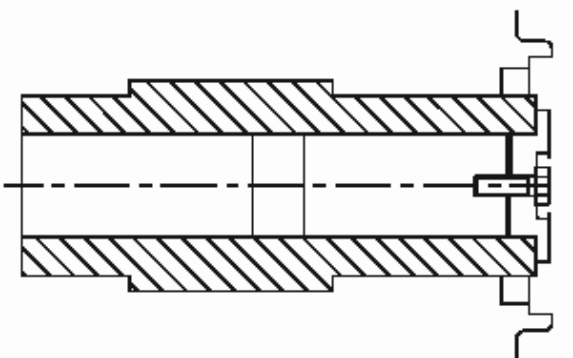

SHAFT MOUNT UNITS RETAINED WITH A RECESSED PLATE AND BOLT

**Torque Arm Details A0280-A0860**

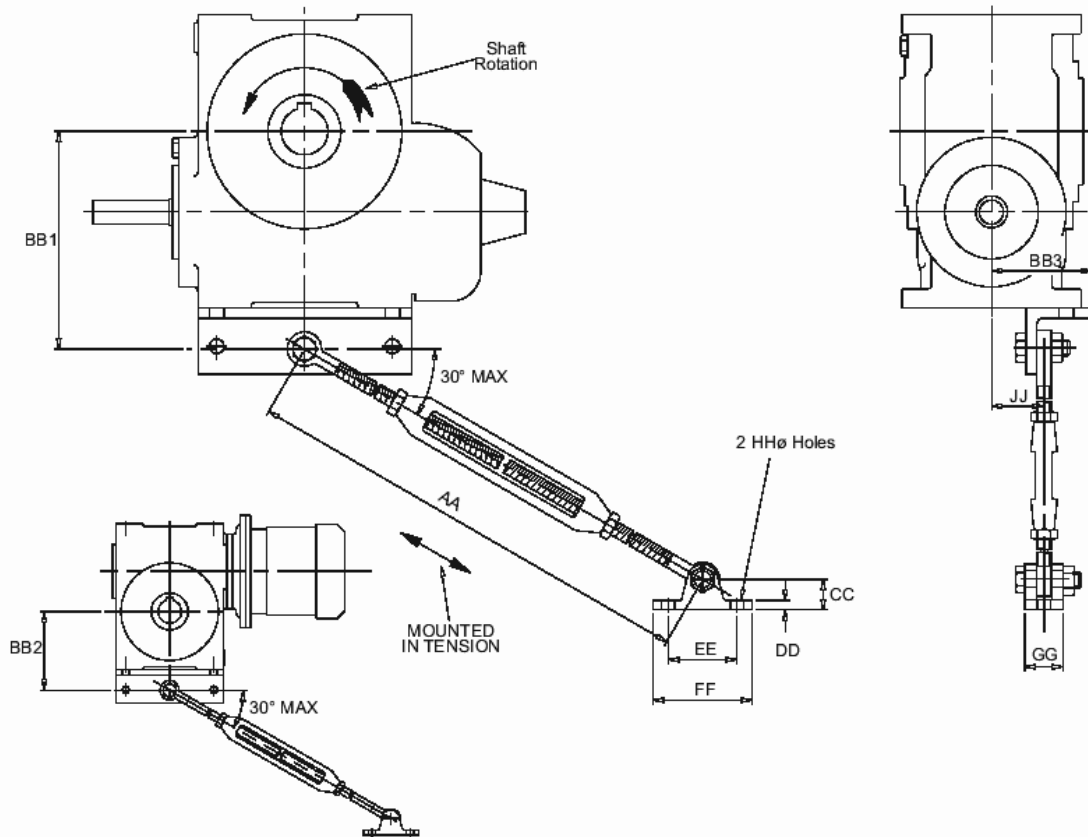

	Size of Unit					
	A0280	A0410	A0510	A0610	A0730	A0860
BB1	100	126	137	163	184	215
BB2	77	91	99	118	136	154
BB3	51	63	66	76	87	100
AA	355-510	355-510	480-635	480-635	480-635	610-750
CC	21	21	25	25	25	30
DD	6	6	8	8	8	10
EE	51	51	57	57	57	70
FF	70	70	83	83	83	102
GG	25	25	30	30	30	38
HH	9	9	11	11	11	14.3
JJ	31	34	38	40	51	58



The torque arm should be fitted on that side of the gear unit which is adjacent to the driven machine.

The angle between the torque arm and the high speed shaft **MUST NOT EXCEED 30°**. The torque arm must be positioned so that it is loaded **IN TENSION**. i.e. In the direction of **TORQUE REACTION**, which is opposite to the direction of shaft rotation, as shown above.

For reversing applications two torque arms must be lifted in opposite mounting positions.

Gear units must be locked axially when mounted in position, and supported by the low speed sleeve for a minimum of 90% of the bore length.

**Torque Arm Banjo Type**

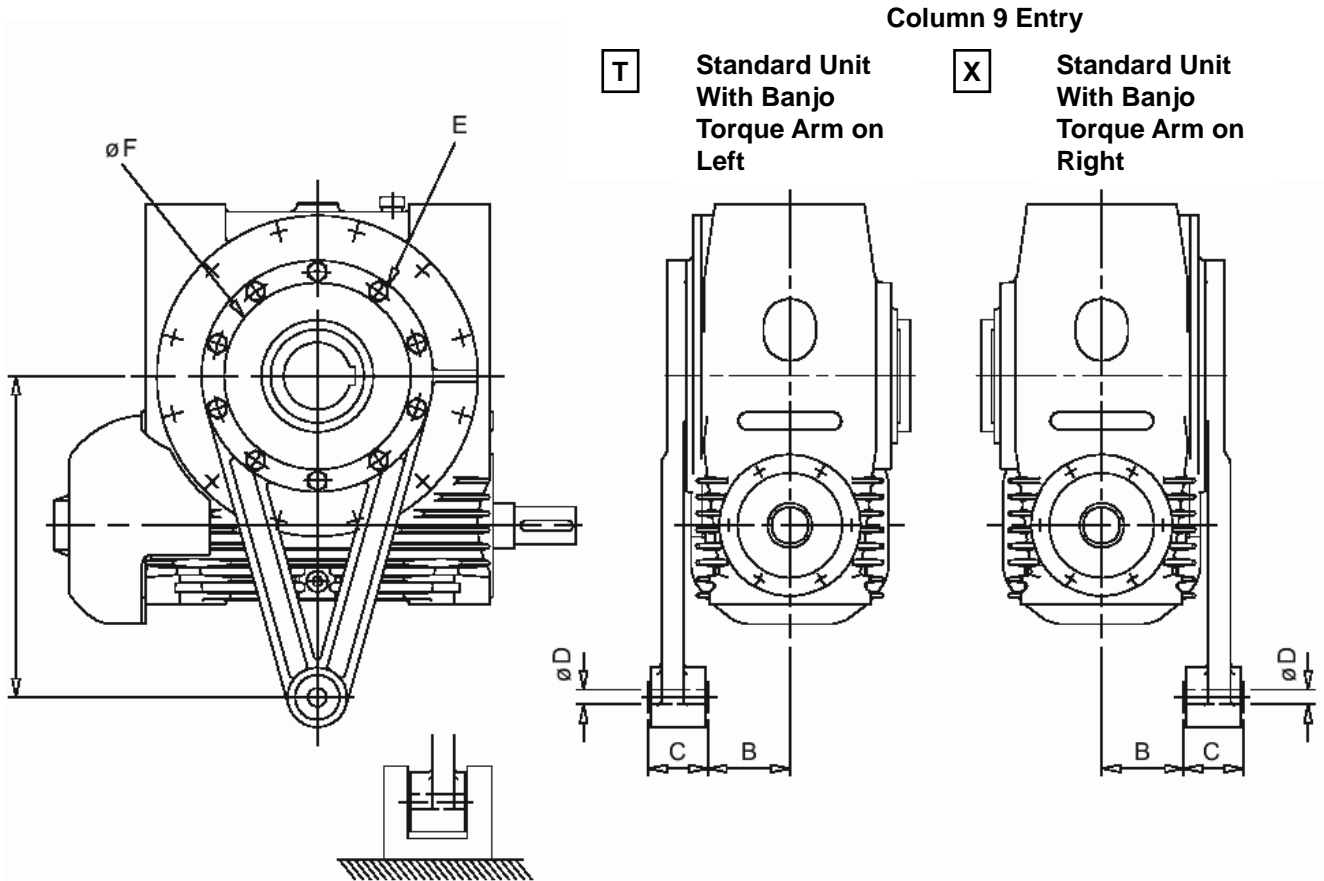

Size of Unit	A	B	C	$\Phi D$	E	$\Phi F$ (Spigot dia)
1002	250	67	60	16.4	6 x M12 on a 155 pcd	132.000/131.937
1252	310	77.5	60	16.4	8 x M12 on a 195 pcd	170.000/169.937
1602	380	84	80	25	6 x M16 on a 230 pcd	200.000/199.928
2002	430	110.5	80	25	10 x M16 on a 280 pcd	250.000/249.928



**NOTE:** It is recommended that the torque arm is fitted on the side of the unit adjacent to the driven machine.

## Three Phase Induction Motor Installation

### Connection to Mains Power Supply

- Connection of the electric motor to the mains supply should be done by a qualified person.
- Connect motor terminals in accordance with the diagram inside the terminal box cover. (Also identified in Figure MI 1 below).



**NOTE:** It is important that the mains supply details are checked against the motor nameplate data and that they are connected as indicated on the nameplate. The correct sizing of the cables to electrical regulations is essential.

- To change the direction of rotation of the electric motor, one of the three main line terminals should be changed with the other.
- Connect the earth conductors to the marked earth terminals.

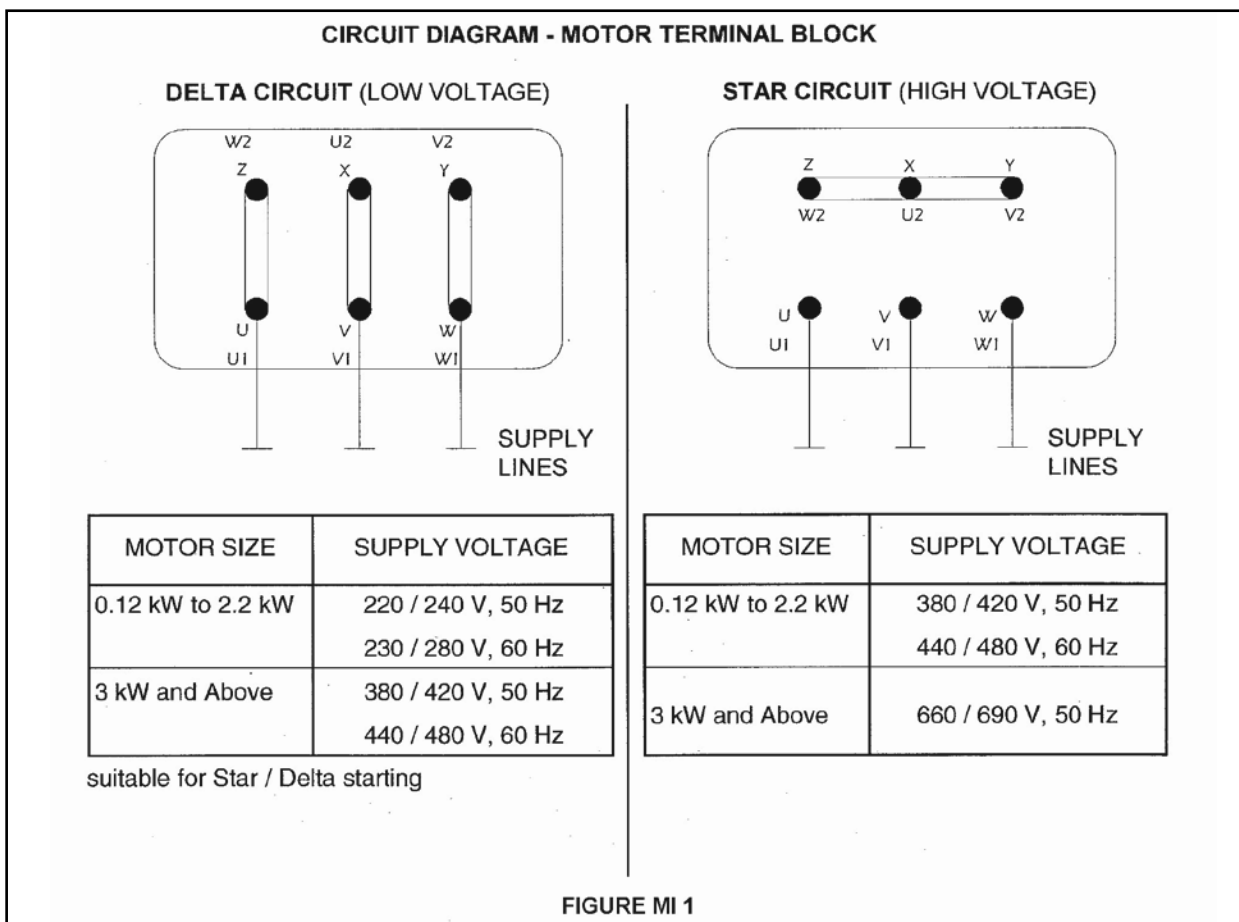

**NOTE:** This instruction only applies to our 'own brand' plated motors. Motors fitted by the customer or requested by our customers from a different manufacturer will have separate documentation provided with it.

## Approved Lubrication

### Lubricant and Quantity

Unit sizes A0280, A0410, A0510, A0610, A0730, A0860 are factory filled with a grade 6G lubricant.

Unit sizes A1002, A1252, A1602, A2002 will be despatched without oil.

Note: Catalogue ratings are based on the ployglycol range of synthetic oils recommended on this page. The use of mineral or special oils will require a derate, please contact our 'application Engineers.

The oil grade is stamped on the name plate and the oil level should be taken using the level plug. These are determined from the operating speed of the gear unit and the ambient temperature range, which if not given when ordering will be assumed to be 1450 rev/min input and ambient temperature range 0 to 35°C. Oil grades and oil level should therefore always be checked before installation, instructions are provided with all units despatched.

To determine the oil grade refer to table 1, and then subsequently to the approved lubricant tables which give approved lubricants for use in our industrial gearboxes.

To determine the oil capacity refer to appropriate table 2 or 3. Oil capacities are only approximate and units should be filled until oil escapes from the level plug holes. Do not overfill as excess will cause overheating and leakage.

### Table 1 : Lubricant Quantity (Litres) Single Reduction A0280-A0860

Applicable for all mounting positions:-

Mounting Position	Unit Size					
	A0280	A0410	A0510	A0610	A0730	A0860
All	0.24(0.31)	0.38(0.48)	0.56(0.74)	1.00(1.28)	2.02(2.62)	3.10(3.94)

For units running at input speeds below 500 rev/min with either the input or output shaft vertical, also for the secondary stage of all double reduction units irrespective of shaft disposition, the oil quantities in brackets, table 1 above are applicable.

### Table 2 : Lubricant Quantity (Litres) Single Reduction A1002-A2002

Mounting Position	Unit Size			
	A1002	A1252	A1602	A2002
1	1.8 (2.3)	3.2 (4.1)	5.4 (7.9)	8.0 (12)
2	2.0 (3.3)	4.0 (6.6)	7.0 (13)	11.4 (21.5)
3 & 4	1.7 (2.1)	3.6 (3.7)	6.6 (7.8)	10(11.5)
5, 6 & Cooling Tower	Refer to Radicon			
Agitator	1.8 (2.1)	3.8 (4.0)	6.7 (7.4)	9.2(10.7)

Figures in brackets refer to :  
 - Mounting position 2 with output shaft speed of 100 rev/min and below (A1002 & A1252), or 150 rev/min and below (A 1602 & A2002)  
 - Mounting positions 1,3 and 4 with input shaft speed of 600rev/min and below.

### Table3 : Lubricant Quantity (Litres) Double Reduction A1002-A2002

Double Reduction Units – obtain primary stage lubricant quantity from table.

Motorised or Reducer	Double Reduction Unit Size									
	A0280	A0410	A0510	A0610	A0730	A0860	A1002	A1252	A1602	A2002
* Secondary Stage	-	A0410	A0510	A0610	A0730	A0860	A1002	A1252	A1602	A2002
Primary Stage	-	A0280	A0280	A0410	A0410	A0510	A0610	A0730	A0860	C0722#

\* Secondary stage units, use oil quantities in brackets in (Table 1 and Table 2)

# C0722, fill to oil level plug maximum oil requirement 6.1 ltrs



## Approved Lubricants

**Type G** Polyglycol based synthetic lubricants with Anti-Wear or EP additives.  
 These have a medium to high load carrying capacity. (see +)  
 Refer to page 23 for ambient temperature ranges.

Supplier	Lubricant Range	Grade Numbers				
		5G	6G	7G	8G	9G
Oil Suppliers Corresponding Designations						
Boxer Services / Millers Oils	Boxergear W	220(-31)	320(-31)	460(-28)		
BP Oil International Limited	Enersyn SG-XP	220(-31)		460(-34)	680(-28)	
Caltex	Snlube CLP	220(-34)	320(-31)	460(-28)	680(-31)	
Carl Bechem GmbH	Berusrsynth EP	220(-25)	320(-25)	460(-25)	680(-28)	1000(-28)
Castrol International	Alphasyn PG	220(-34)	320(-31)	460(-28)		
Esso/Exxon	Glycolube	220(-25)	320(-25)	460(-23)		
Fuchs Lubricants	Renolin PG	220(-34)	320(-34)	460(-34)	680(-28)	1000(-28)
Klüber Lubrication	Klüber synth GH6	220(-25)	320(-25)	460(-20)	680(-20)	1000(-28)
	Klüber synth UH1 6	220(-30)	320(-25)	460(-25)		
Kuwait Petroleum International	Q8 Gade	220(-22)	320(-22)	460(-22)		
Laporte Performance chemicals Limited	Berox Industrial Lubricant SW	220(-25)	320(-25)	460(-23)	680(-20)	1000(-28)
	Berox SL Range	220(-40)	320(-37)	460(-23)		
	Berox Oil Solule Industrial Lube x	220(-23)				
Mobil Oil Company Limited	Glygoyle	30(-22)	HE320(-37)	HE460(-35)		
Optimal Olwerke GmbH	Optiflex A +	220(-28)	320(-28)	460(-28)	680(-28)	1000(-25)
Shell Oils	Tivela	SB(-25)	SC(-25)	SD(-23)		
	Tivela S	220(-34)	320(-34)	460(-34)		
Texaco Limited	Synlube CLP	220(-34)	320(-31)	460(-10)	680(-31)	
Total	Carter SY	220(-25)	320(-28)	460(-22)		
Tribol GmbH	Tribol 800	220(-27)	320(-25)	460(-25)	680(-25)	1000(-23)

+ Not suitable for applications requiring industrial EP Additives

x This particular lubricant is compatible with types M,A,E and H

**Note :** Type G lubricants will affect certain gearcase paints and shrink certain seals, contact Application Engineering before use.

**DANGER:** Numbers in brackets indicate the minimum pour point temperature of the specified oil in °C  
**THE UNIT MUST NOT BE RUN BELOW THIS TEMPERATURE.**











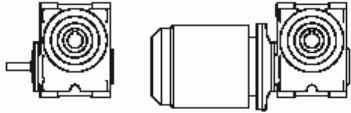
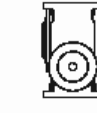
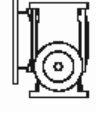
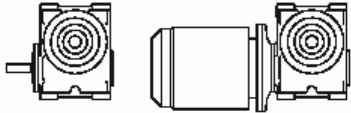
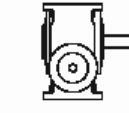
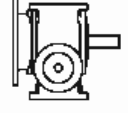
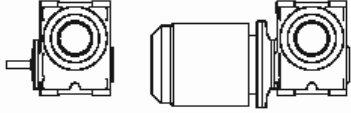
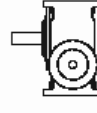
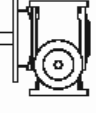
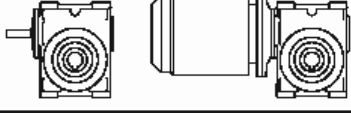
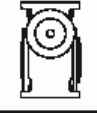
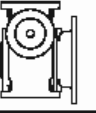
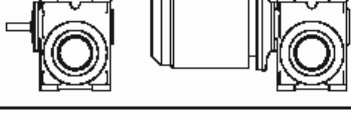
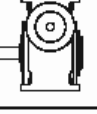
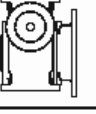

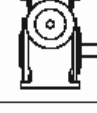
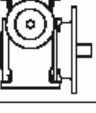
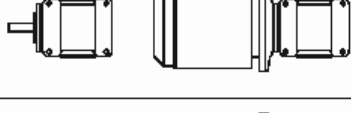

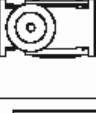

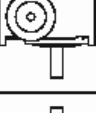
## Approved Lubricants

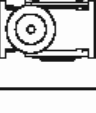
**Type H** Polyalphaolefin based synthetic lubricants with Anti-Wear or EP additives.  
These have a medium to high load carrying capacity.

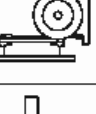

SUPPLIER	LUBRICANT RANGE	GRADE NUMBERS	
		5H	6H
		AMBIENT TEMPERATURE RANGE °C	
		-30 to 35	20 to 50
Batoyle Freedom	Titan	220 (-31)	320 (-28)
Boxer Services / Millers Oils	Silkgear	220 (-35)	320 (-35)
BP Oil International Limited	Enersyn EPX		320 (-28)
Caltex	Pinnacle EP	220 (-43)	320 (-43)
Carl Bechem GmbH	Berusynth GP	220 (-38)	320 (-35)
Castrol International	Alphasyn EP	220 (-37)	320 (-31)
	Alphasyn T	220 (-31)	320 (-28)
Chevron International Oil Co	Tegra	220 (-46)	320 (-33)
Esso/Exxon	Spartan Synthetic EP	220 (-46)	320 (-43)
Fuchs Lubricants	Renogear SG	220 (-32)	320 (-30)
	Renolin Unisyn CLP	220 (-37)	320 (-34)
Klüber Lubrication	Klübersynth GEM4	220 (-30)	320 (-25)
Kuwait Petroleum International	Q8 El Greco	220 (-22)	320 (-19)
Lubrication Engineers Inc.	Synolec Gear Lubricant	9920 (-40)	
Mobil Oil Company Limited	Mobilgear SHC	220 (-40)	320 (-37)
	Mobil gear XMP	220 (-40)	320 (-33)
Optimal Ölwerke GmbH	Optigear Synthetic A	220 (-31)	320 (-31)
Petro-Canada	Super Gear Fluid	220 (-43)	320 (-37)
Shell Oils	Omala HD	220 (-43)	320 (-40)
Texaco Limited	Pinnacle EP	220 (-43)	320 (-43)
	Pinnacle WM	220 (-43)	320 (-40)
Total	Carter EP/HT	220 (-34)	320 (-31)
Tribol GmbH	Tribol 1510	220 (-36)	320 (-33)

**DANGER:** Numbers in brackets indicate the minimum pour point temperature of the specified oil in °C  
**THE UNIT MUST NOT BE RUN BELOW THIS TEMPERATURE.**





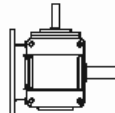
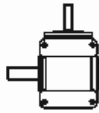
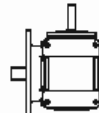
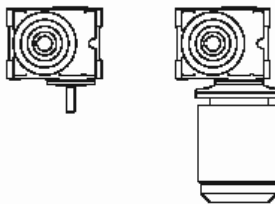

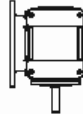
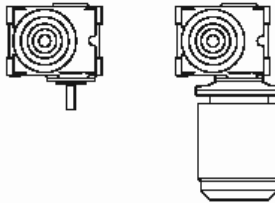
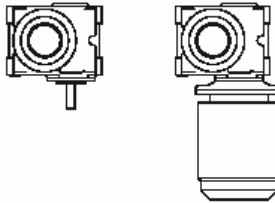
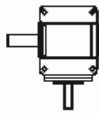



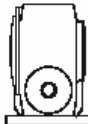
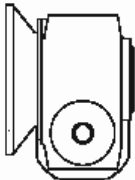
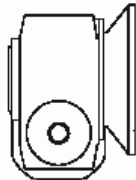
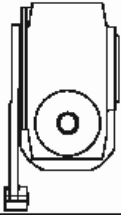
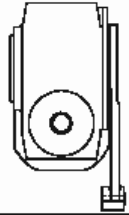

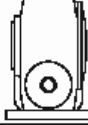

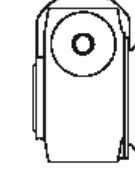
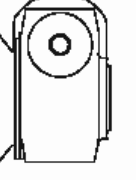

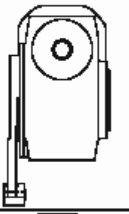
**Handings and Mounting Positions A0280 to A0860**

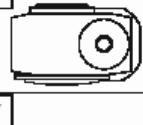
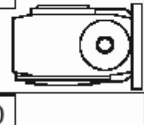
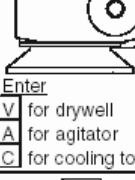
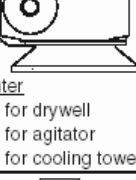
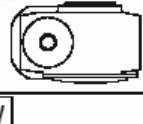
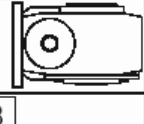
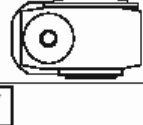
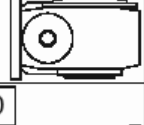
COLUMN 13 ENTRY	DOUBLE OUTPUT SHAFTS ARE AVAILABLE FOR ALL MOUNTING POSITIONS		
A			
B			
C			
D			
E			
F			
G			
H			
J			
K			
M			
N			

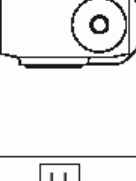
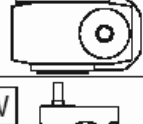
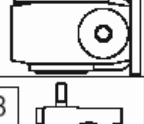
## Handings and Mounting Positions A0280 to A0860

COLUMN 13 ENTRY	DOUBLE OUTPUT SHAFTS ARE AVAILABLE FOR ALL MOUNTING POSITIONS		
P			
S			
T			
W			
X			
Y			

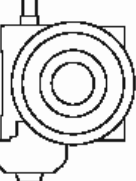
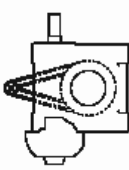
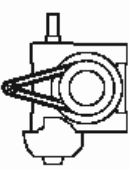
**Handings and Mounting Positions A1002 to A2002**

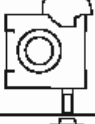
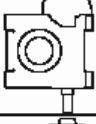
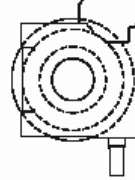
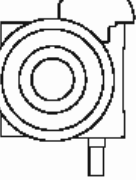
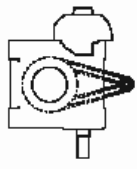
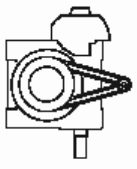
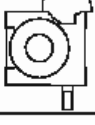
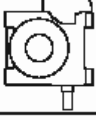



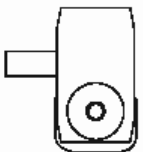
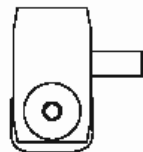
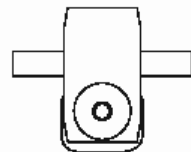
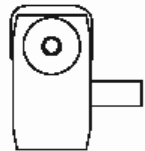
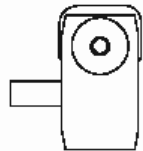
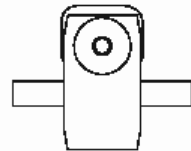
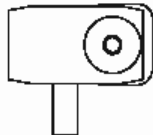
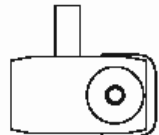
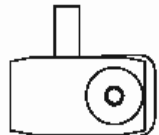
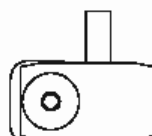
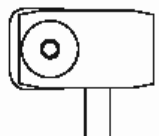
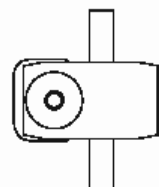
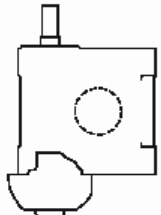
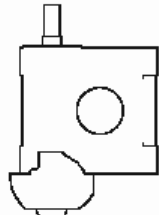
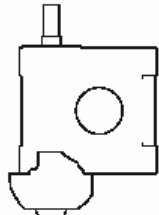
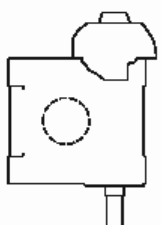
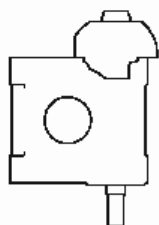
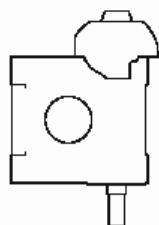





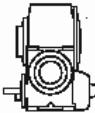
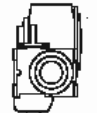
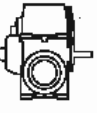

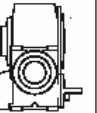
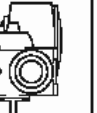
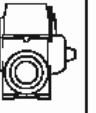
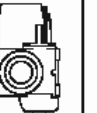
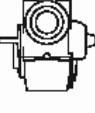

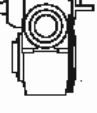
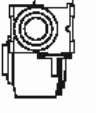

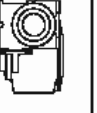



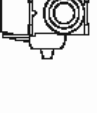



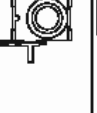
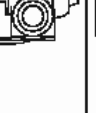
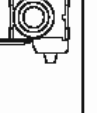



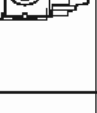

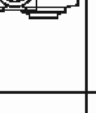



Column 13 Entry	Unit Version - Column 9 Entry					
	Basic Unit	Base mounted feet	Output flange		Banjo torque arm	
1	W 	B 	F 	H 	T 	X 
	Y 	D 				
2	W 	B 	F 	H 	T 	X 
	Y 	D 				
3	W 	B 	F 	H 	T	X
	Y 	D 	Enter V for drywell A for agitator C for cooling tower	Enter V for drywell A for agitator C for cooling tower	-	-
4	W 	B 	F 	H 	T	X
	Y 	D 			-	-
5	W 	B 	F 	H 	T 	X 
	Y 	D 				
6	W 	B 	F 	H 	T 	X 
	Y 	D 				

## Handings and Mounting Positions A1002 to A2002

Column 13 Entry	Output Shaft Positions - Column 11 Entry		
	<b>C</b> (F) Single extension	<b>E</b> (J) Single extension	<b>D</b> (G) Double extension
<b>1</b>			
<b>2</b>			
<b>3</b>			
<b>4</b>			
<b>5</b>			
<b>6</b>			

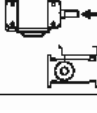
Letters in brackets indicate reduced diameter output shafts, see page 16 for details.

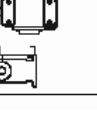
**Double Reduction Primary Unit Mounting Position**

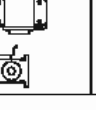
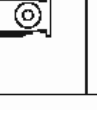
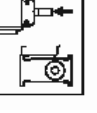
Column 13 Entry	Primary Unit Mounting Position - Column 14 Entry							
	1	2	3	4	5	6	7	8
1								
2								
3								
4								
5								
6								

FOR SINGLE REDUCTION ENTER  IN COLUMN 14

SIZE 2002 MOTORISED, ONLY PRIMARY MOUNTING POSITIONS 1, 2, 3 AND 4 ARE AVAILABLE

**Approved Bearing Greases.**

Supplier	Lubricant Range	Allowable Operating Temperature Range °C	
		Above	To
BP Oil International Limited	Energrease LS-EP	-30	130
Caltex	Multifak EP	0	120
Castrol International	LMX Grease	-40	150
	Spheerol AP	-30	110
	Spheerol EPL	-10	120
Fuchs Lubricants	Renolit EP	-25	100
Klüber Lubrication	Klüberlub BE 41-542	-20	140
Mobil Oil Company Limited	Mobilgrease XHP	-15	150
	Mobilith SHC	-20	180
Omega Manufacturing Division	Omega 85	-40	230
Optimol Ölwerke GmbH	Longtime PD	-45	140
Shell Oils	Albida RL	-20	150
	Alvania EP B	-20	120
	Nerita HV	-30	130
Texaco Limited	Multifak All Purpose EP	-30	140

- Note :**
1. All above greases are NLGI grade 2.
  2. Refer to our Application Engineers if the unit is operating in an ambient temperature outside the range of -30°C to 50°C.



---

## NOTES



# CONTACT US

## AUSTRALIA

**Radicon Transmission  
(Australia) PTY Ltd**  
Australia

Tel: +61 488 054 028

## EUROPE

**Benzler TBA BV**  
Jachthavenweg 2  
NL-5928 NT Venlo

Austria  
Tel: +43 7 229 618 91  
Fax: +43 7 229 618 84

France  
Tel: +33 687 718 711  
Fax: +31 77 324 59 01

Germany  
Tel: 0800 350 40 00  
Fax: 0800 350 40 01

Italy  
Tel: +39 02 824 3511

Netherlands & the rest of Europe  
Tel: +31 77 324 59 00  
Fax: +31 77 324 59 01

## DENMARK

**Benzler Transmission A/S**  
Fuglebævej 3D  
DK-2770 Kastrup,  
Denmark

Tel: +45 36 34 03 00  
Fax: +45 36 77 02 42

## FINLAND

**Oy Benzler AB**  
Vanha Talvitie 3C  
FI-00580 Helsingfors,  
Finland

Tel: +358 9 340 1716  
Fax: +358 10 296 2072

## INDIA

**Elecon. Engineering  
Company Ltd.**  
Anand Sojitra Road  
Vallabh Vidyanagar  
388120 Gujarat  
India

Tel: +91 2692 236513  
Fax: +91 2692 227484

## SWEDEN & NORWAY

**AB Benzlers**  
Box 922 (Landskronavägen 1)  
251 09 Helsingborg  
Sweden

Tel: +46 42 18 68 00  
Fax: +46 42 21 88 03

## THAILAND

**Radicon Transmission  
(Thailand) Ltd**  
700/43 Moo 6  
Amata Nakorn Industrial Estate  
Tumbol Klongtumru  
Muang,  
Chonburi  
20000  
Thailand

Tel: +66 3845 9044  
Fax: +66 3821 3655

## UNITED KINGDOM

**Radicon Transmission UK Ltd**  
Unit J3  
Lowfields Business Park,  
Lowfields Way, Elland  
West Yorkshire, HX5 9DA

Tel: +44 (0) 1484 465 800  
Fax: +44 (0) 1484 465 801

## USA

**Radicon USA Transmission Ltd**  
1599 Lunt Avenue  
Elk Grove Village  
Chicago  
Illinois  
60007  
USA

Tel: +1 847 593 9910  
Fax: +1 847 593 9950

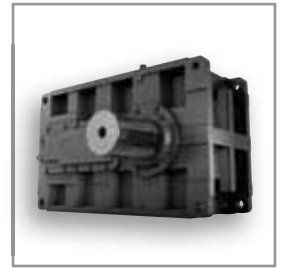
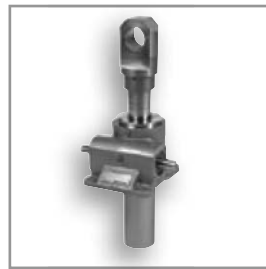

benzlers☀

**Benzlers**

Denmark +45 36 34 03 00  
Finland +358 9 340 1716  
Germany +49 800-350 4000  
Sweden +46 42 186800  
The Netherlands +31 77 324 59 00  
[www.benzlers.com](http://www.benzlers.com)

**Radicon**

Thailand +66 3845 9044  
United Kingdom +44 (0) 1484 465 800  
USA +1 847 593 9910